

MARSHALL-TUFFLEX

Bendex Challenger System 1 & 2 Trunking



UK OWNED
UK MANUFACTURER



INSTALLATION INSTRUCTIONS

PLANNING INSTALLATION

Establish layout, paying attention to; direction of changes, Feed position & Component spacing.

CLEANING

The exterior should be cleaned using a damp cloth.

DISPOSAL

The product and packaging should be disposed of via standard civic amenity facilities.

To ensure a safe installation, this product must be installed by a skilled or instructed person, in accordance with the current edition of IEE wiring regulations (BS 7671) and building regulations.

For product classification refer to DOC03685 (System 1) or DOC03686 (System 2). Additionally, 1 and 2 Gang Frames conform to the requirements of BS 4662 where applicable. If you are in any doubt regarding the installation or application of the product, please contact: The Technical Team on +44 (0) 1424 856688

PVC-U expands / contracts at a uniform rate of approx. 7mm in 4m length for a temperature change of 25°C

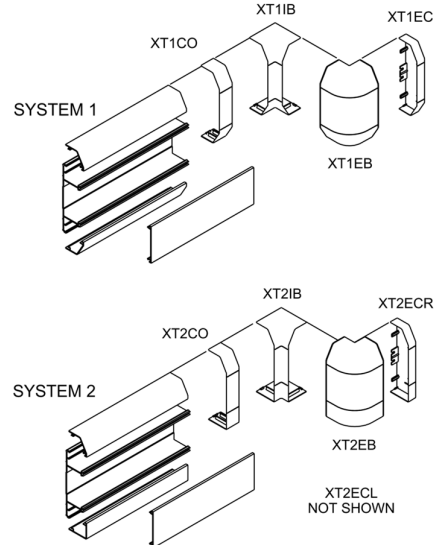

[1] When fitting trunking be mindful of

When used as skirting system or run against a vertical wall, sufficient clearance must be allowed for between floor covering or wall and the profile fittings that clip over the covers (End Cap, Coupler, Flat Angle and Flat Tee)

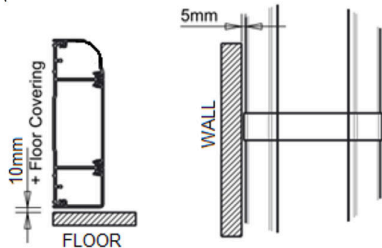

[2] Base and Covers

To cut the trunking, use a fine-toothed panel or power jigsaw. Allow 3mm between each successive length of base for thermal expansion. Every cover to be cut back by 8mm from the end of the base

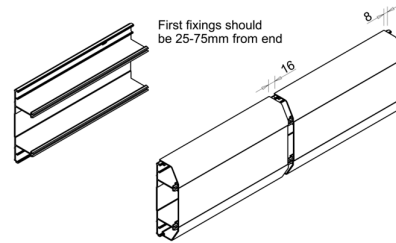

To fasten the base use No.8 round head screws & washers, avoid over tightening to permit thermal movement. Alternative top and bottom fixing at 200mm centres using pre-punched slots. Use of plastic caps over screw heads is recommended to protect cables.

[3] Retention of Fittings

All fittings clip into the trunking base with exception of the End Caps. No additional fastening device is necessary. All are provided with a generous 10mm overlap at joints, to accommodate thermal expansion and to compensate for errors in cutting.

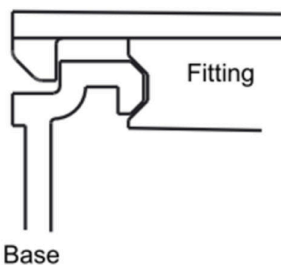

[4] Secured End Cap

End Caps butt up to the end of the base. Fixing screws are required for retention of end cap to meet classification. No.8 screws are recommended.

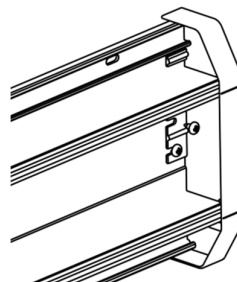

[5] Internal & External Bends

Base can be mitred 45° to ensure total enclosure of cables or for external bend base can be cut square to wall.



Allow 3mm gap for thermal expansion

[6] Internal Bends

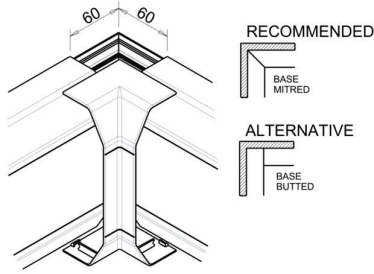

After fixing base to corner, fit covers with offset as shown then clip internal bend in place.

[7] External Bends

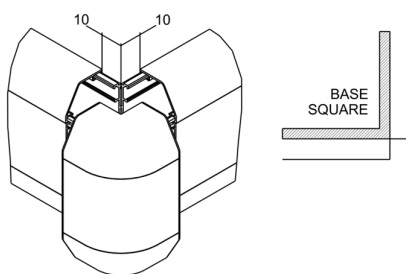

After fixing base to corner, fit covers with offset as shown then clip external bend in place.

[8] Offset Dimensions

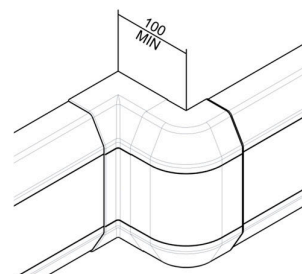

The minimum set that can be accommodated in the same plane (from internal to external bend)

[9] Cover removal

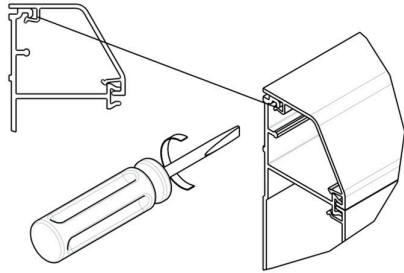

The lids have been designed to remain in position irrespective of impact during normal conditions and minor undulations of the fixing surface. Lids are designed to limit their unauthorised removal. All lids peel off, although curved and square lids can be eased from the base by inserting a screwdriver between the captive legs of the lid and base. The lids can then be peeled from the base.

[10] Method of Continuation Through a Partition Wall

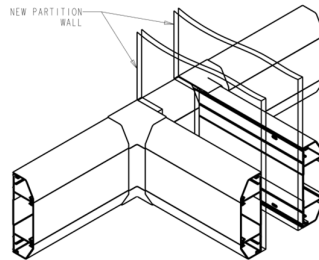

Continue the main lateral run of base through the partition with short lengths of cover fitted where the trunking passes through the partition. The partition wall trunking is then butted up to the main run and the joint covered by an internal bend.

[11] Short Length

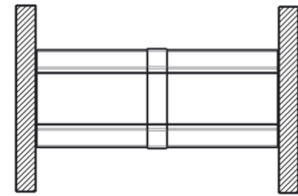

To fit a single length of trunking (under 3 metres) between two inside walls and with no accessory box fitted; it is advisable to install a coupler in the centre of the run to facilitate the removal of the cover.

[12] Flat Angle and Flat Tee

Flat angle and Flat tee are supplied with radius control as standard, these need to be fitted to the wall first with the trunking base butted up to the moulded radius control.

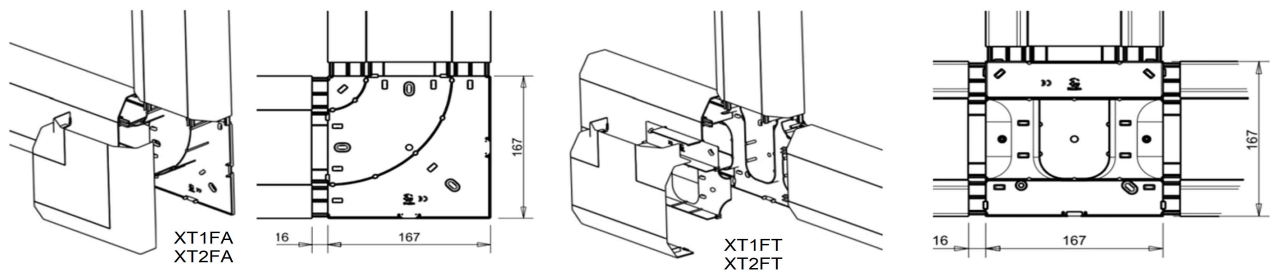

The covers clip over the base with the trunking lids set back 16mm from the end of the trunking. No couplers are required as Angle Cover / Tee Cover overlap the trunking lids.